

## Alerting system for railway tunnels

Various trials under real conditions have shown, that the already existing alerting system and system for self-rescue in railway tunnels do only conditionally serve their purpose.

Weak spots have been discovered and in cooperation with SBB Ltd. and various planning agencies, it was searched for possible solutions.

GIFAS-Electric GmbH has given hands and in cooperation with other companies has developed a system to satisfy all exigencies.



Amelioration of the measurements for self-rescue in the base tunnel Zimmerberg  
(Zurich – Thalwil)

## Base

Based on the existing system (equipped with an emergency lamp and GIFAS junction boxes E30) the auxiliary- respectively substitute installation could be realised in a simple manner.

### Schematic overview:

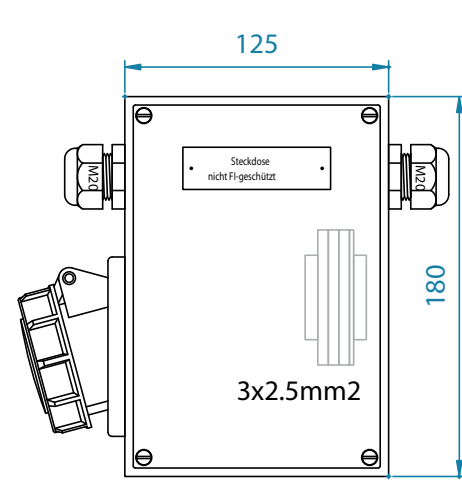
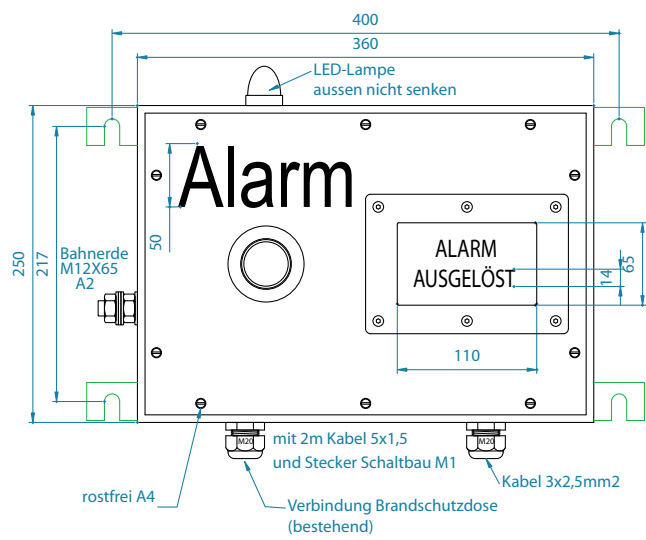
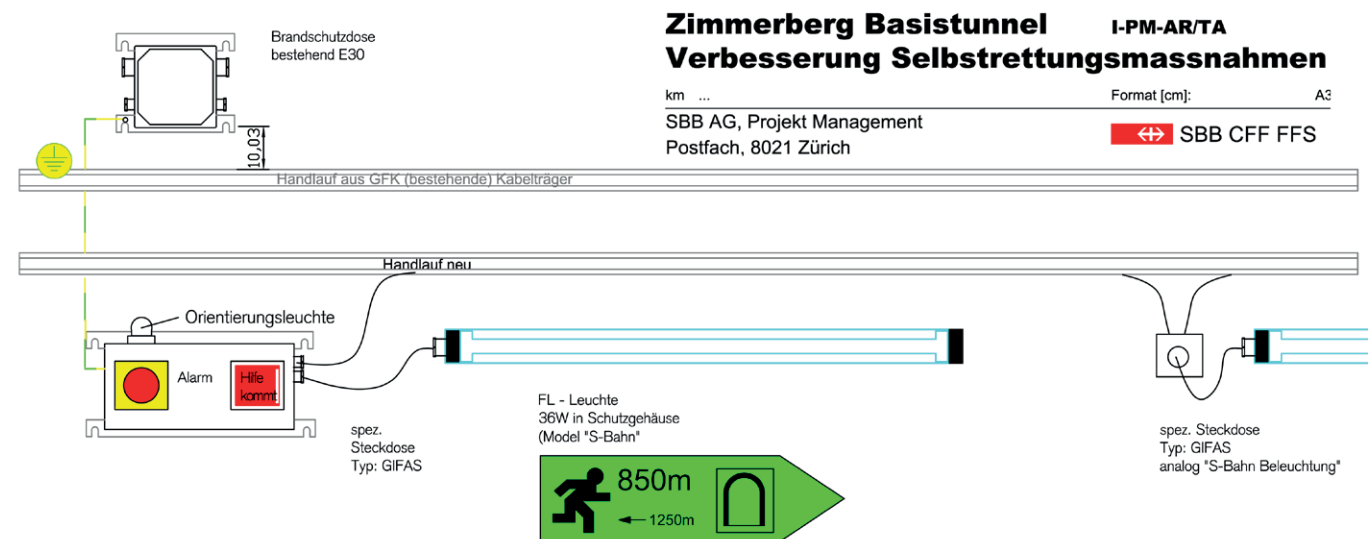

V 0113

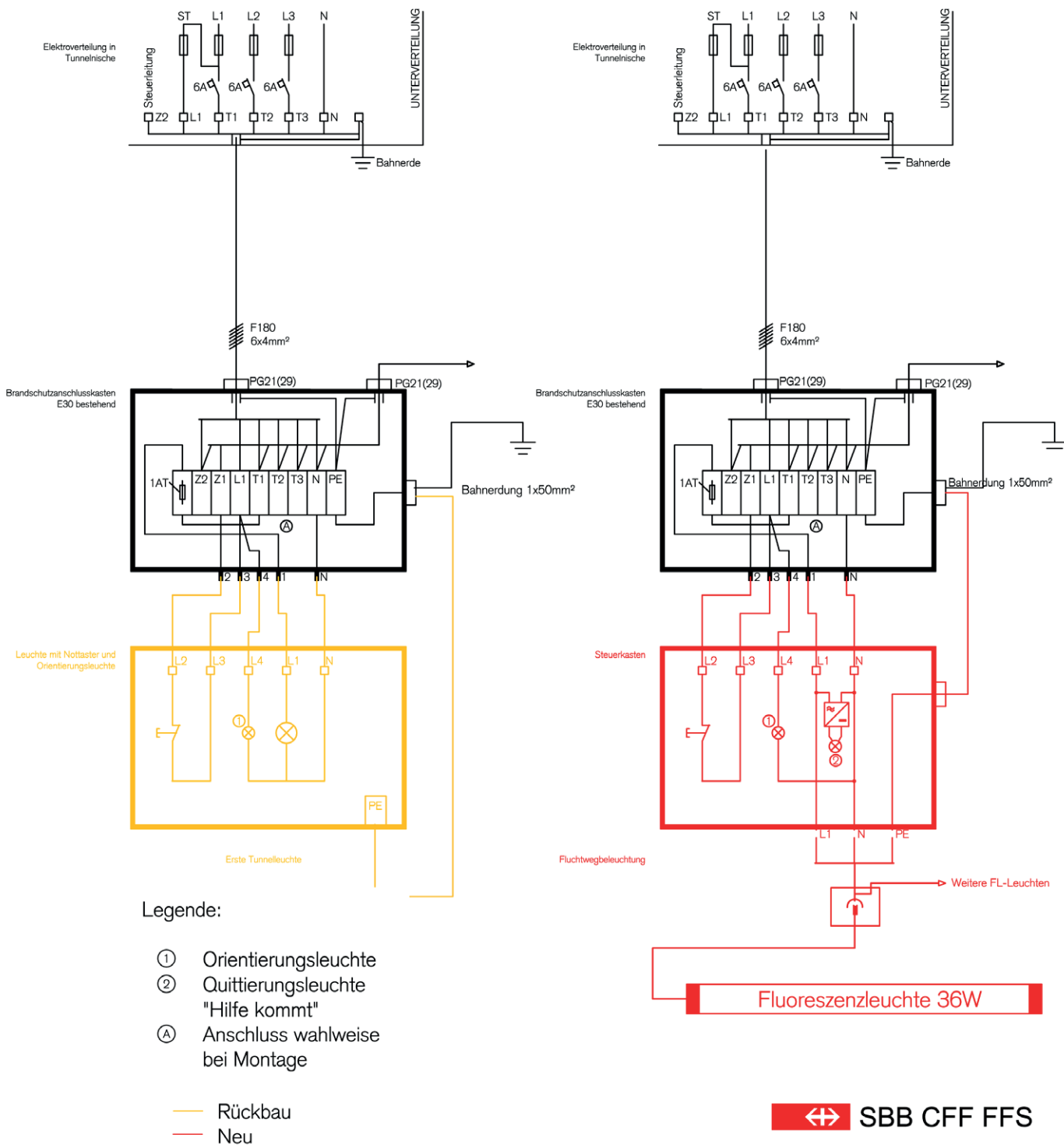

V 0113

Further developments

The spacious conditions are not everywhere so vast as in the Zimmerberg tunnel. For this reason we have already enhanced the alerting units. For this type we have left out the orientation lamps (® application only for short railway tunnels).

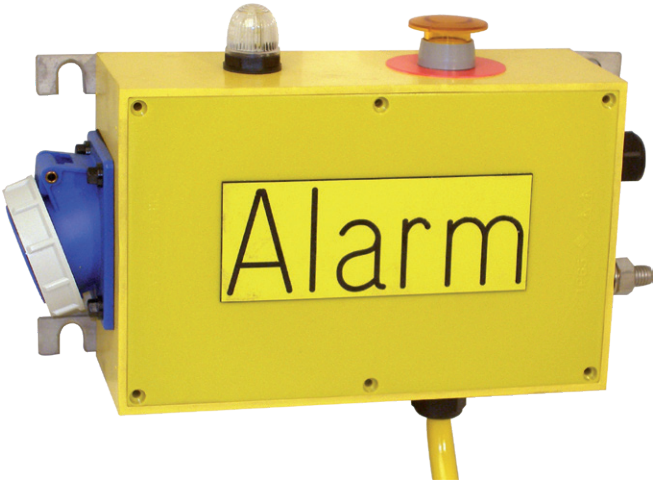

Some impressions



V 0113

**Solution:**

- Pressure resistant push button switch (>9000 Nm<sup>2</sup>) with backlight, in order to avoid a release by compressed air
- LED lamp to confirm, "alarm activated" – to confirm the alarm release in case of emergency
- Orientation LED lamp permanently burning
- Fire-proof junction box E30 to secure the power supply in case of emergency
- Power supply to illuminate tunnels in case of emergency
- Safety tubular light GT to illuminate the tunnel in case of emergency
- Junction box for plug connection of FL-lamps

The installation of the Zimmerberg tunnel consisting of 1560 junction boxes and approx. 390 alerting units was completed in an unprecedented action.

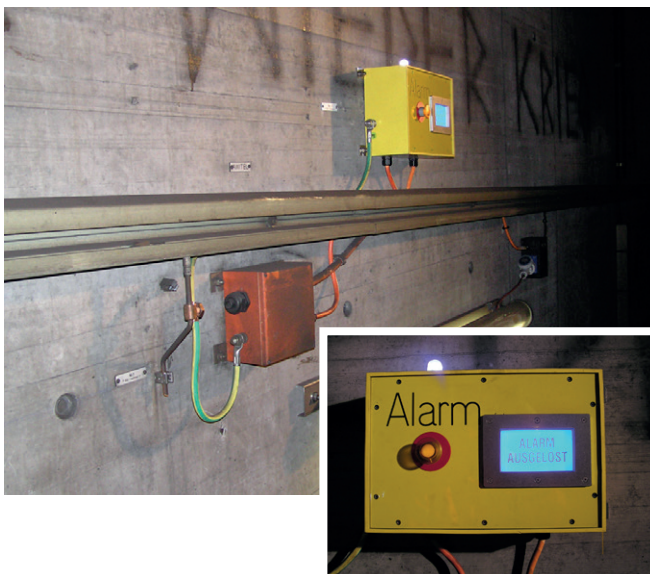

**New development**

**Our power – innovation!**

In view of the fact that adequate products are not available on the market, we are producing the desired orientation lamps in LED technology ourselves within a few weeks!

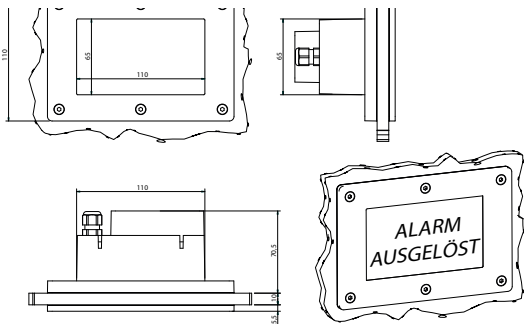

V 0113